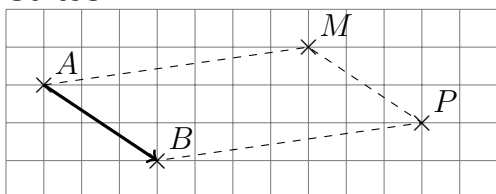
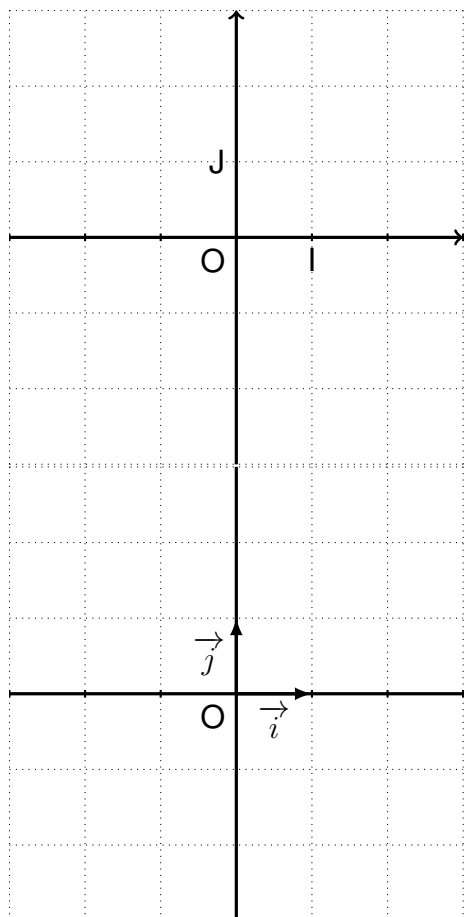

Table des matières

1 repères	1
2 Utilisation de scope	2
3 rectangle arrondi	2
a. Figures	3
▶ projeté orthogonal	3
4 trigonométrie	4
a. Cercle Complet	7
5 nombres complexes	8
a. Cube	9
6 Suites	10



1 repères



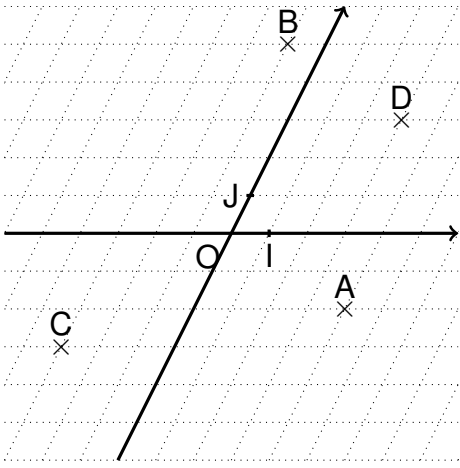

2 Utilisation de scope

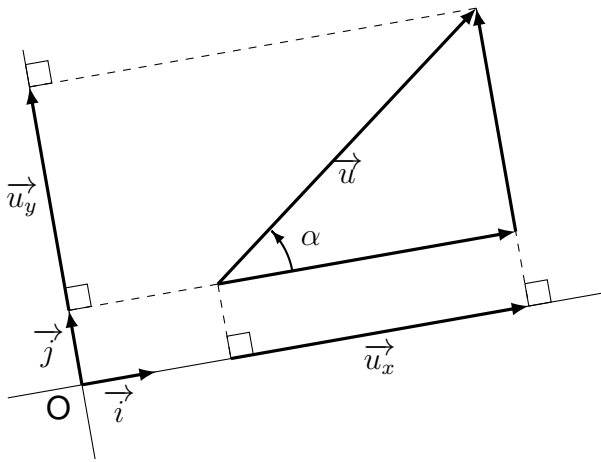

3 rectangle arrondi

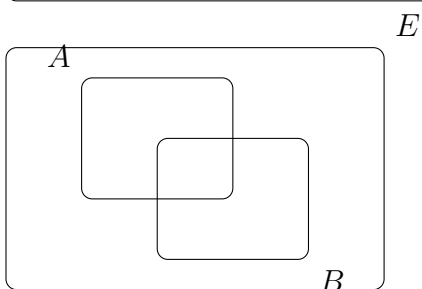
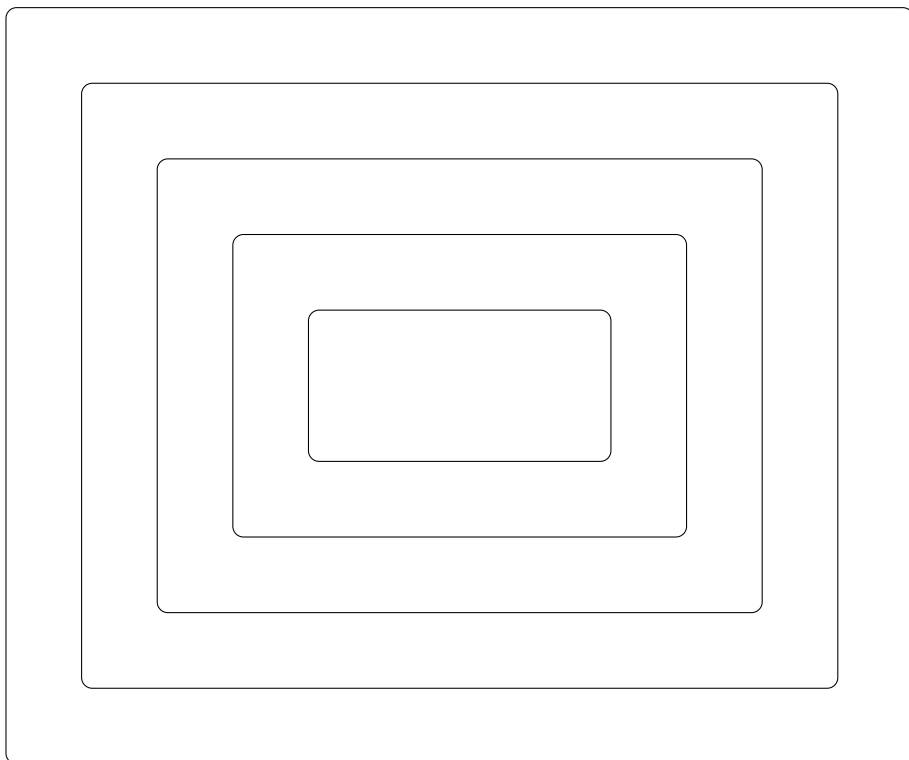

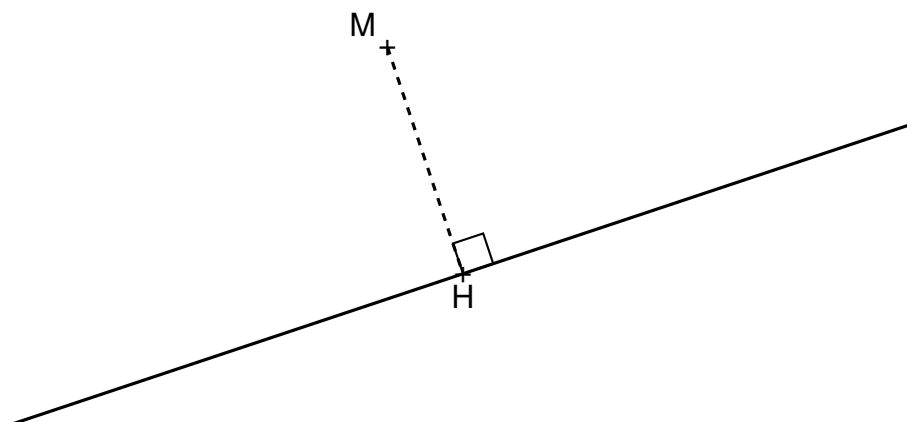

a. Figures

► projeté orthogonal

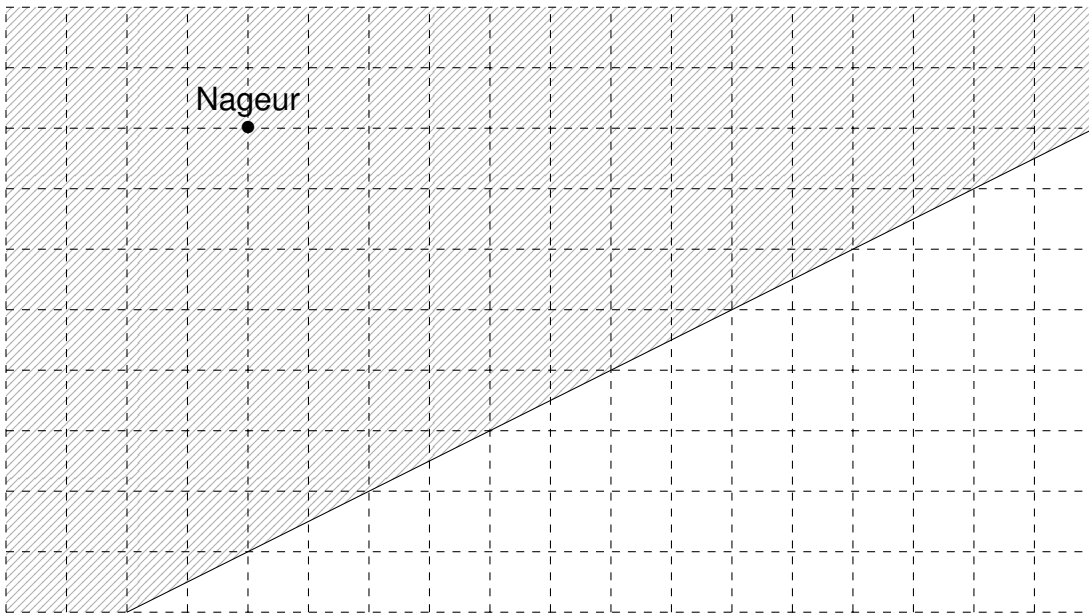
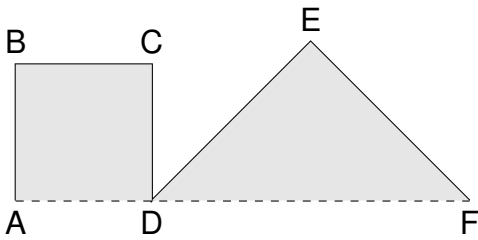
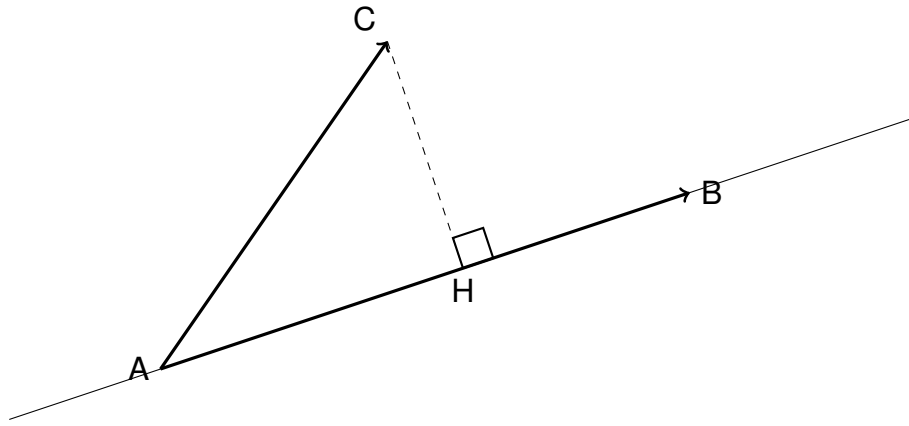



-  Mer
-  Sable
-  10 m

4 trigonométrie

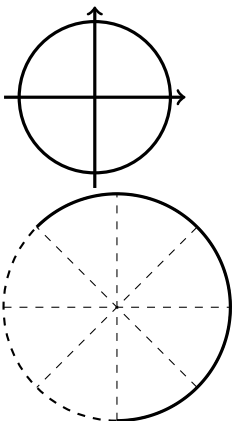

Le rayon du cercle en pointillé est 1, quelle la longueur de l'arc de cercle en traits plein ? ()

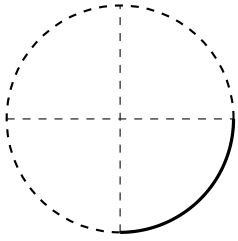

Longueur : ... (a)

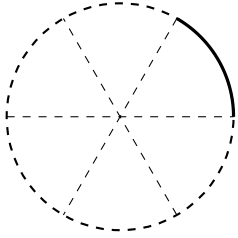

Longueur : ... (b)

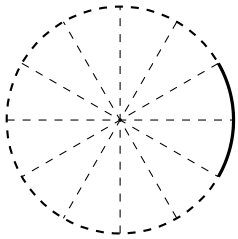

Longueur : ...

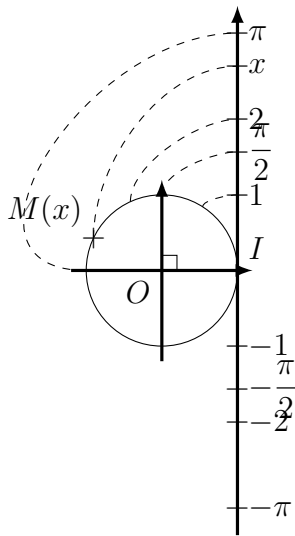

Des repérages à connaître

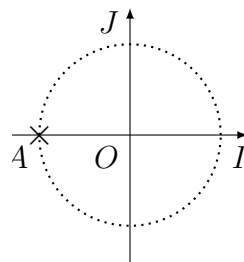

A est repéré par :

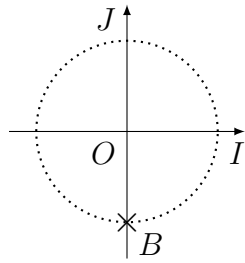

B est repéré par :

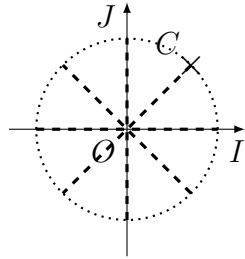

C est repéré par :

Mesures remarquables - correspondances en degrés

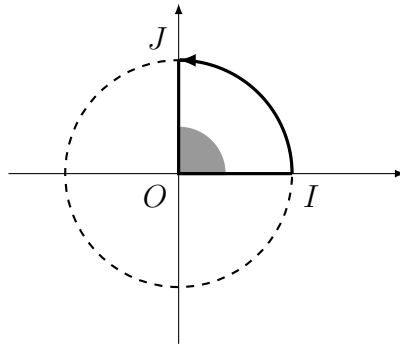

Mesure en radian : ...
 Mesure en degré : ...

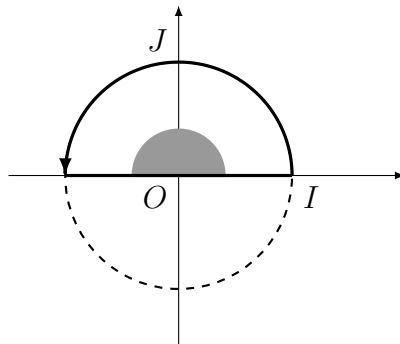

Mesure en radian : ...
 Mesure en degré : ...

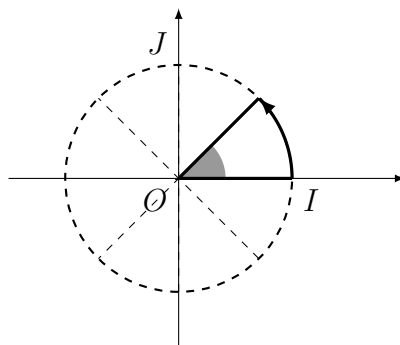

Mesure en radian : ...
 Mesure en degré : ...

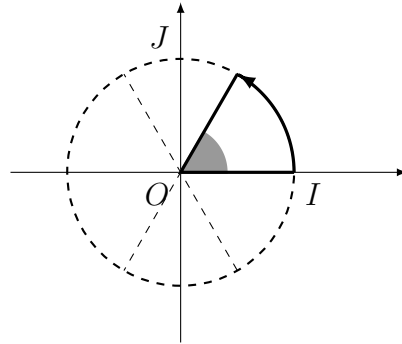

Mesure en radian : ...
 Mesure en degré : ...

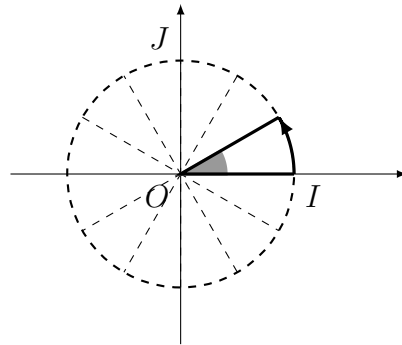

Mesure en radian : ...
 Mesure en degré : ...

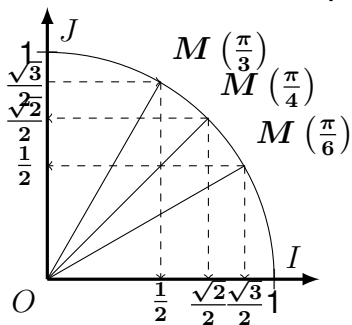
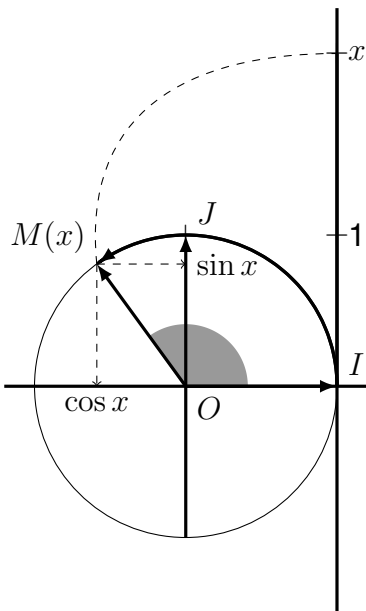

a. Cercle Complet

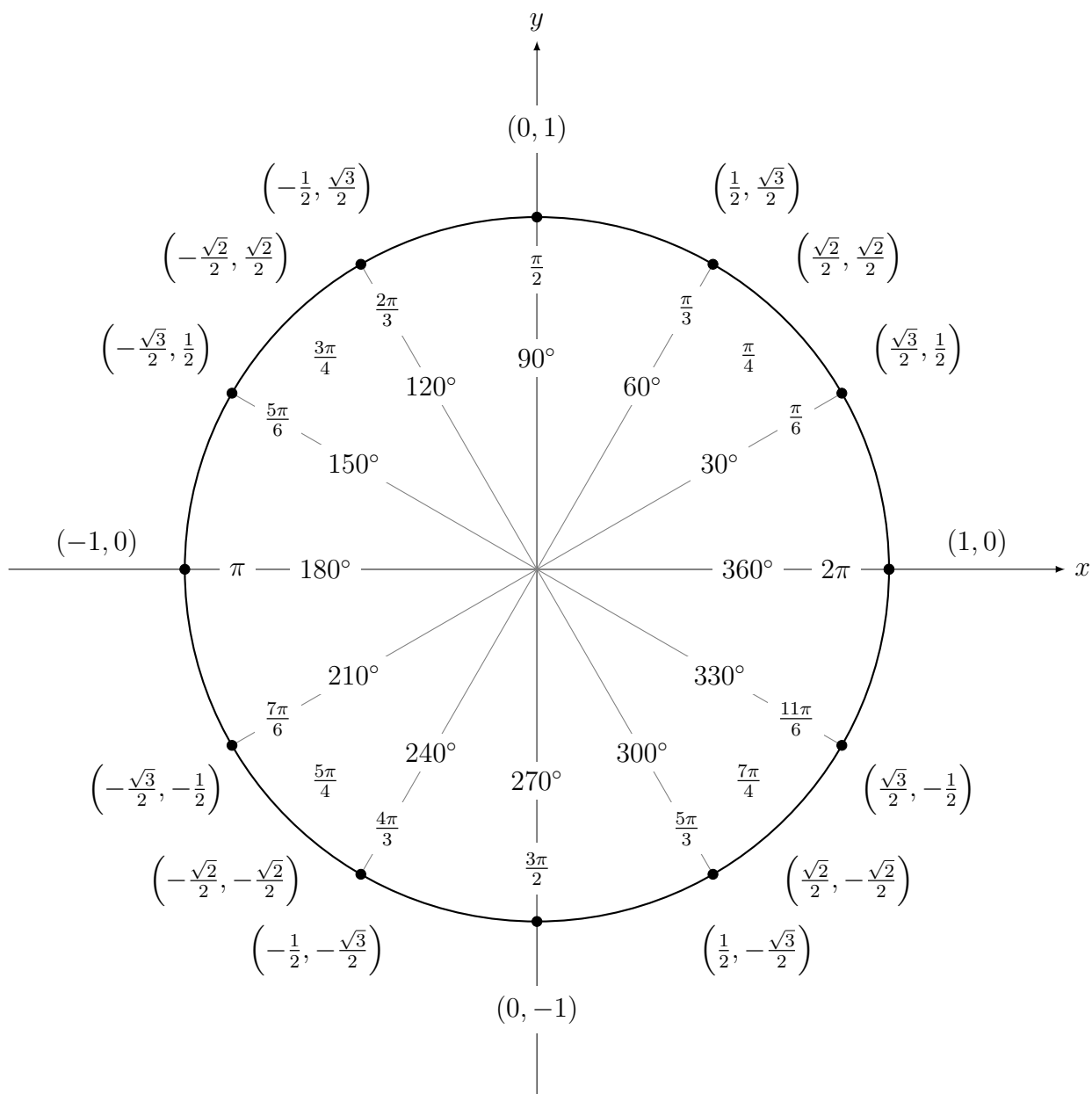

5 nombres complexes

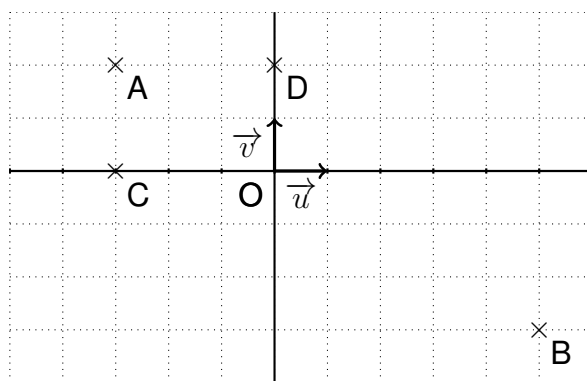

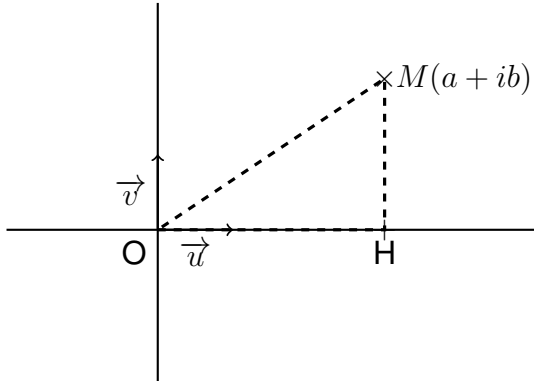
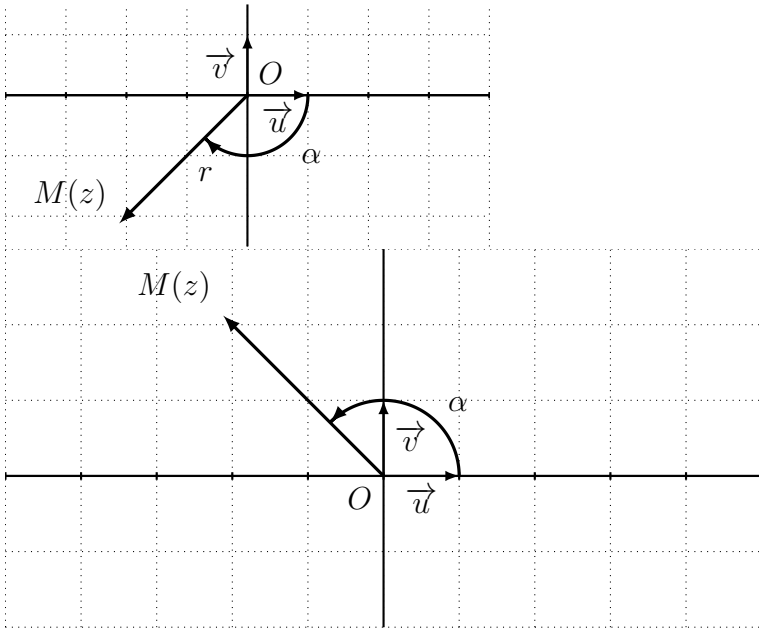

racines 3 de l'unité :
 $n = 3$

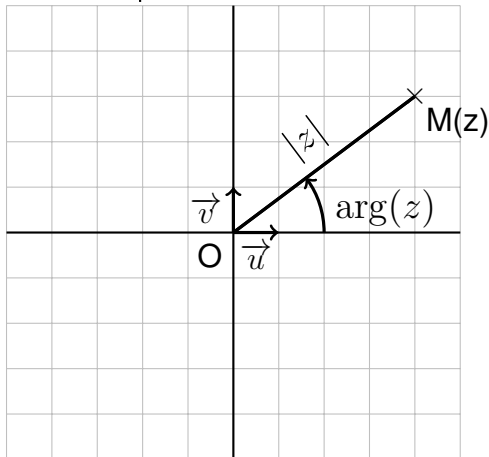
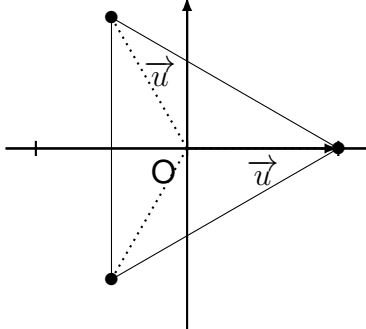

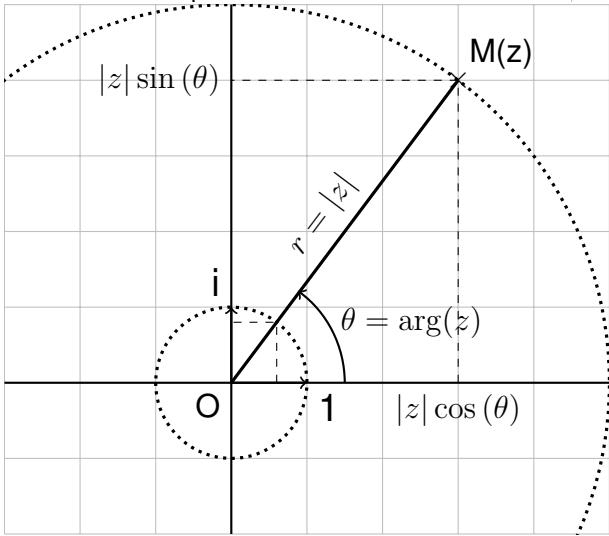
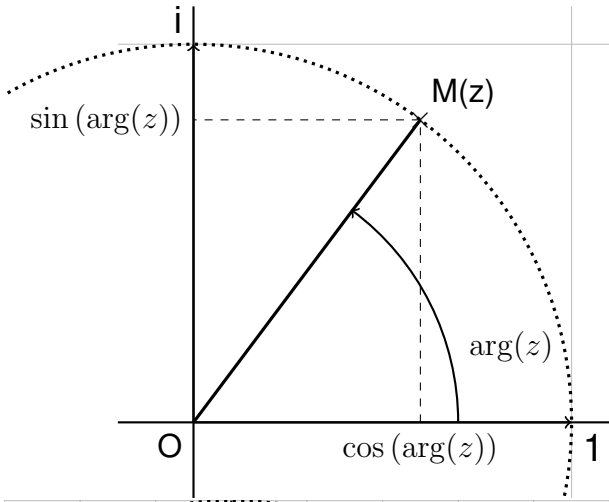

a. Cube

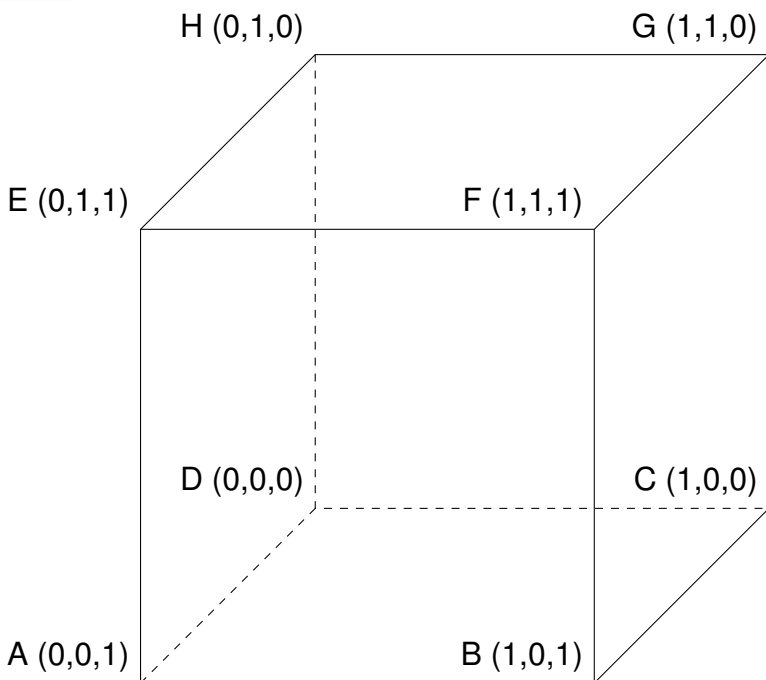
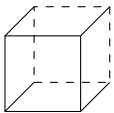

6 Suites

